









ALFORD ACADEMY PARENT COUNCIL OUTDOOR SPACE PROJECT



Examples of outdoor social seating/shelters available through Aberdeenshire Council approved suppliers.



Equipment	Supplier	No. of pupils	Minimum Space Required (LxW)m	Cost (£) (excl VAT)	Delivery (£)	Installation	Snow loading	Warranty	Leadtime (weeks)
OC Shelter with Benches and Panels 	Scotplay & Sports Limited	25	7.0 x 6.4	10,352.65	Included in cost	Included in cost. Use a local contractor for the installation or send a team up from Glasgow if required	Designed with snow loading in mind, do not have certification	Timbers installed with steel ground foot and come with 20-year guarantee	8
https://www.scotplay.co.uk/product/educational-play/outdoor-classrooms/shelter/							Data sheet p10		
Shelter Spree Forest 	Jupiter Play & Leisure		6.85 x 6.0	16,780.00	1,753.00	6,000.00 Use local Contractor in the Aberdeenshire area – Playscapes Ltd		15 Year guarantee on timber against rotting or structural failure	12-14
https://jupiterplay.co.uk/products/outdoor-furniture-timber-shelter/							Data sheet p11		

Equipment	Supplier	No. of pupils	Minimum Space Required (LxW)m	Cost (£) (excl VAT)	Delivery (£)	Installation	Snow loading	Warranty	Leadtime (weeks)
Modular School Shelter (3 bays) with 7 benches and 7 panels 	Scotplay & Sports Limited	35		15,250.70	Included in cost	Included in cost. Use a local contractor for the installation or send a team up from Glasgow if required	Designed with snow loading in mind, do not have certification	Timbers installed with steel ground foot and come with 20-year guarantee	8
https://www.scotplay.co.uk/product/educational-play/outdoor-classrooms/modular-school-shelter/									
Shelter Soren 	Jupiter Play & Leisure		5.85 x 8.05	12,325.00	1,924.00	4,500.00 Use local Contractor in the Aberdeenshire area – Playscapes Ltd		15 Year guarantee on timber against rotting or structural failure	12-14
https://jupiterplay.co.uk/products/shelter-soren/							Data sheet p12		

Equipment	Supplier	No. of pupils	Minimum Space Required (LxW)m	Cost (£) (excl VAT)	Delivery (£)	Installation	Snow loading	Warranty	Leadtime (weeks)
Encounter 19 	Scotplay & Sports Limited	19 - 20	9.2 x 8.0	1,3916.55	Included in cost	Included in cost. Use a local contractor for the installation or send a team up from Glasgow if required	Designed with snow loading in mind, do not have certification		8
https://www.scotplay.co.uk/product/playground-extras/social-seating-shelters/encounter-19/							Data sheet p13		
Encounter 3 	Scotplay & Sports Limited	3	5.0 x 3.5	714.25	Included in cost	Included in cost. Use a local contractor for the installation or send a team up from Glasgow if required	Designed with snow loading in mind, do not have certification		8
https://www.scotplay.co.uk/product/playground-extras/social-seating-shelters/encounter-3/							Data sheet p14		

Equipment	Supplier	No. of pupils	Minimum Space Required (LxW)m	Cost (£) (excl VAT)	Delivery (£)	Installation	Snow loading	Warranty	Leadtime (weeks)
Encounter 6 	Scotplay & Sports Limited	6 - 10	4.7 x 5.6	6,929.88	Included in cost	Included in cost. Use a local contractor for the installation or send a team up from Glasgow if required	Designed with snow loading in mind, do not have certification		8
https://www.scotplay.co.uk/product/playground-extras/social-seating-shelters/encounter-6/							Data sheet p15		
PCM704 Meeting Point with Movable Hammocks 	KOMPAN Scotland Limited	12	6.3 x 6.35	9,760.00	Not included in cost	Not included. Recommend Steven Christi Landscapes. Recently installed a few of these teen shelters in Forres.	Slant on each roof is designed for snow loading	Lifetime warranty on all our steel products and 2 years on moving parts	6-7
https://www.kompan.com/en/gb/p/pcm704							Data sheet p16		

Equipment	Supplier	No. of pupils	Minimum Space Required (LxW)m	Cost (£) (excl VAT)	Delivery (£)	Installation	Snow loading	Warranty	Leadtime (weeks)
FRE3000 Cosmos Meeting Point 	KOMPAN Scotland Limited	n/k	3.90 x 2.54	5,140.00	Not included in cost	Not included. Recommend Steven Christi Landscapes	Slant on each roof is designed for snow loading	Lifetime warranty on all our steel products and 2 years on moving parts	6-7
https://www.kompan.com/en/gb/p/fre3000							Data sheet p17		
PCM701 Movable Hammocks 	KOMPAN Scotland Limited	6	6.3 x 5.03	4,560.00	Not included in cost	Not included. Recommend Steven Christi Landscapes	Slant on each roof is designed for snow loading	Lifetime warranty on all our steel products and 2 years on moving parts	6-7
https://www.kompan.com/en/gb/p/pcm701							Data sheet p18		

Equipment	Supplier	No. of pupils	Minimum Space Required (LxW)m	Cost (£) (excl VAT)	Delivery (£)	Installation	Snow loading	Warranty	Leadtime (weeks)
PCM702 Meeting Point 	KOMPAN Scotland Limited	2	4.19 x 3.59	1,220.00	Not included in cost	Not included. Recommend Steven Christi Landscapes	Slant on each roof is designed for snow loading	Lifetime warranty on all our steel products and 2 years on moving parts	6-7
https://www.kompan.com/en/gb/p/pcm702							Data sheet p19		
PCM703 Meeting Point with Bench 	KOMPAN Scotland Limited	6	6.06 x 4.12	3,330.00	Not included in cost	Not included. Recommend Steven Christi Landscapes	Slant on each roof is designed for snow loading	Lifetime warranty on all our steel products and 2 years on moving parts	6-7
https://www.kompan.com/en/gb/p/pcm703							Data sheet p20		

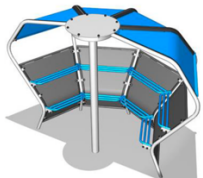
Equipment	Supplier	No. of pupils	Minimum Space Required (LxW)m	Cost (£) (excl VAT)	Delivery (£)	Installation	Snow loading	Warranty	Leadtime (weeks)
PCM805 Hammock with galvanised posts 	KOMPAN Scotland Limited	2	6.96 x 4.30	2,750.00	Not included in cost	Not included. Recommend Steven Christi Landscapes	Slant on each roof is designed for snow loading	Lifetime warranty on all our steel products and 2 years on moving parts	6-7
https://www.kompan.com/en/gb/p/pcm805									
YOU240 Open Half Pod Shelter 	Sutcliffe Play (Scotland) Ltd	-	8.0 x 6.5	8490.00	339.60	Not included in cost	-	-	-
https://www.sutcliffeplay.co.uk/equipment/value-pod-1-2-pod/							Data sheet p21		

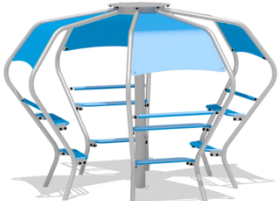
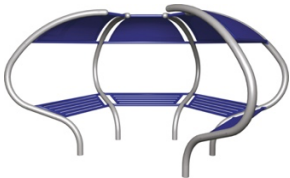
Equipment	Supplier	No. of pupils	Minimum Space Required (LxW)m	Cost (£) (excl VAT)	Delivery (£)	Installation	Snow loading	Warranty	Leadtime (weeks)
YOU245 Open Split Pod Shelter 	Sutcliffe Play (Scotland) Ltd	-	8.0 x 8.0	9610.00	384.40	Not included in cost -	-	-	-
https://www.sutcliffeplay.co.uk/equipment/value-pod-split-pod/							Data sheet p22		
Arena Meeting Point (4 seat) 	Hags SMP Limited		3.18 x 3.66					20 years failure or defects 10 years for galvanized and other non-painted steel and metal parts, solid plastic panels and engineered wood. metal parts	
https://hags.co.uk/en-gb/sport-fitness/ball-sports/accessories/arena-meeting-point-15							Data sheet p23		

Data sheets

OC Shelter with Benches and Panels

Outdoor Classrooms – Shelter Option 2

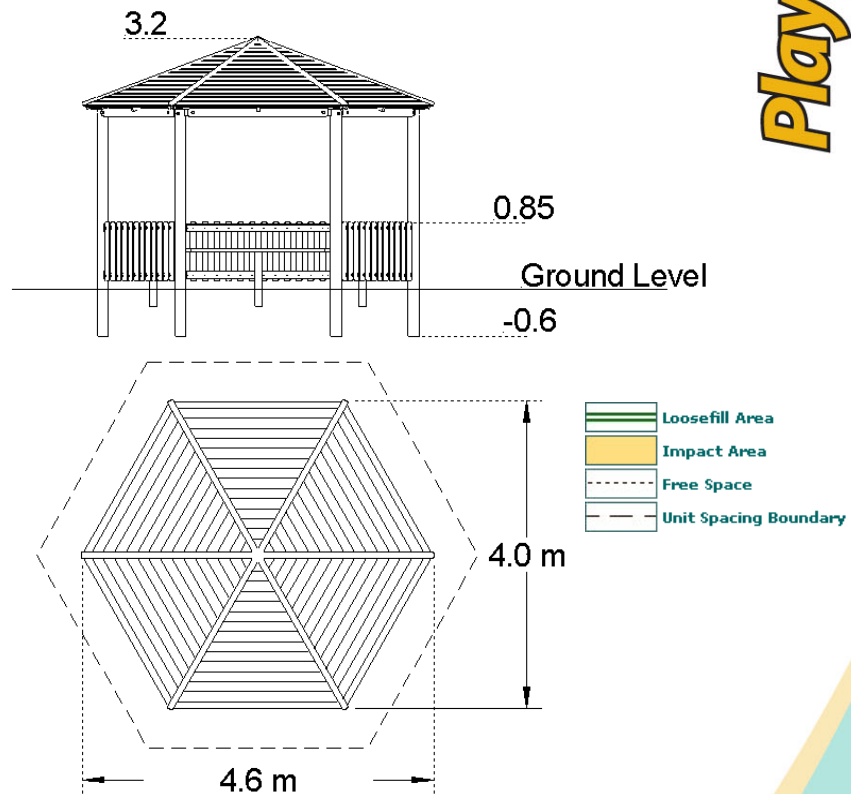

Technical Information	
Equipment Dimensions	
Length / Width / Height	4.6m x 4.0m x 3.3m
Surfacing And Area Required	
Minimum Space Required L/W/H	7.0m x 6.4m x 4.5m
Max Gradient of Ground	1in30
Free Height of Fall	N/A
Impact Area	N/A
Loosefill at 150mm	N/A
Bark / Cushionfall / Sand	N/A
Grasslok Tiles	N/A
Installation Information	
Overall Weight	945kg
Heaviest Part	36kg
Largest Part	2.25m x 0.87m x 0.07m
Longest Part	2.9m
Concrete Required	0.34m ³

Shelter Spree Forest

Product Specification Sheet for:
Shelter Spree Forest 909620500R



Product Name	Shelter Spree Forest Diameter 5m
Product Code	909620500R
Material	BS EN 350-02 Class 1 Robinia Timber
Product Category	FHS Playground Equipment
Age Range	All Ages
Product Type	FHS Furniture and Shelters
Fixings	Stainless Steel Fixings & Galvanised Plates
Free Space Area m2	41.1
Free Space Loosefill m2	41.1
Area Required (LxW)	600 x 685
Grassmat Total	n/a
Edge Length LM	n/a

Plan View
 Not to scale

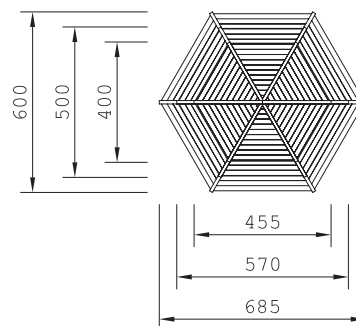

Product Description

Our outdoor roofed shelter provides integrated seating for both formal and informal places to sit. This creates places to rest within the park or to give adults and carers the possibility for soft supervision of play in comfort. It also creates a social area for older children.



The Inclusive Play logo highlights the pieces of equipment most suitable to users of varying abilities.

www.jupiterplay.co.uk
info@jupiterplay.co.uk

HEAD OFFICE: 0131 445 7989
 SOUTHERN OFFICE: 0115 969 9859

Company No. SC200761
 © Jupiter Play & Leisure Ltd. 2014.

Shelter Soren

Product Specification Sheet for:
Shelter Soren 909245400R



Compliant to EN1176

Product Name	Shelter Soren
Product Code	909245400R
Material	BS EN 350-02 Class 1 Robinia Timber
Product Category	FHS Furniture
Age Range	N/A
Product Type	Seating
Fixings	Stainless Steel Fixings & Galvanised Plates
Free Space Area m2	N/A
Free Space Loosefill m2	N/A
FFH	0.85
Area Required (LxW)	5.05 x 8.05
Grassmat Total (M ²)	N/A
Edge Length LM	N/A

Plan View
 Not to scale

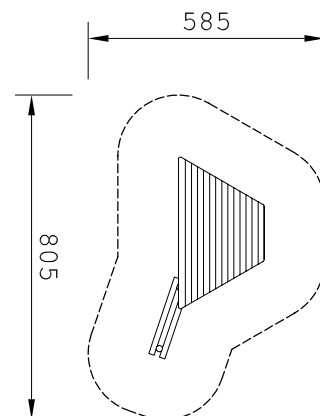

Product Description

The Shelter Soren is a natural seating arrangement that can be easily adapted to be made larger or smaller. It is sure to enhance any natural play space. The timber ensures that even protected landscapes retain a natural feel whilst creating a seating area suitable for all.



Company No. SC200761
 © Jupiter Play & Leisure Ltd. 2014.

www.jupiterplay.co.uk
info@jupiterplay.co.uk

HEAD OFFICE: 0131 445 7989
 SOUTHERN OFFICE: 0115 969 9859

Encounter 19

-  Loosefill Area
-  Hardstanding Area
-  Free Space
-  Unit Spacing Boundary

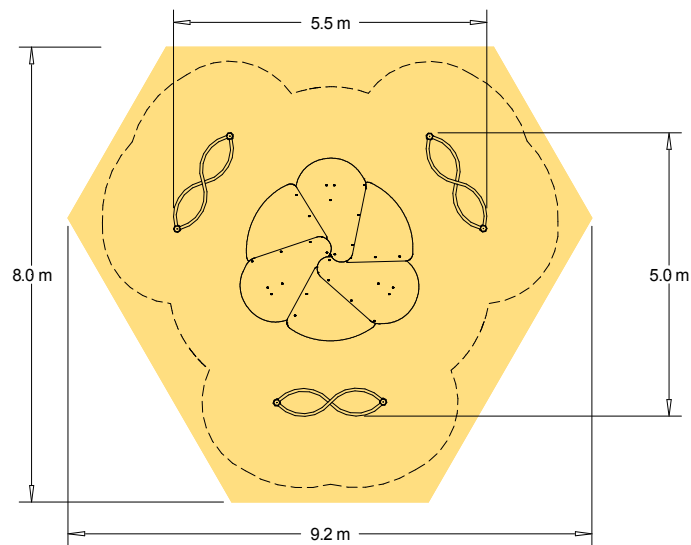
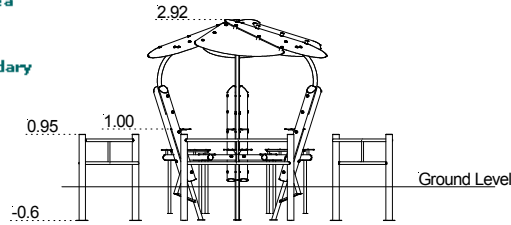

Technical Information	
Equipment Dimensions	
Length / Width / Height	5.5 x 5.0 x 2.9 m
Surfacing and Area Required	
Minimum Space Required L/W/H	9.2 x 8.0 x 4.1 m
Max Gradient Of Ground	1 in 30
Free Height Of Fall	-
Suggested Hardstanding Area	54 m ²
Loosefill At 150mm	-
Bark / Cushionfall / Sand	-
Grasslok Tiles	-
Installation Information	
Overall Weight	726 kg
Heaviest Part	28 kg
Largest Part	2.9 x 1.0 x .05 m
Longest Part	2.9 m
Concrete Required	0.8 m ³

Encounter 3

Encounter 3

Playdale
Playgrounds

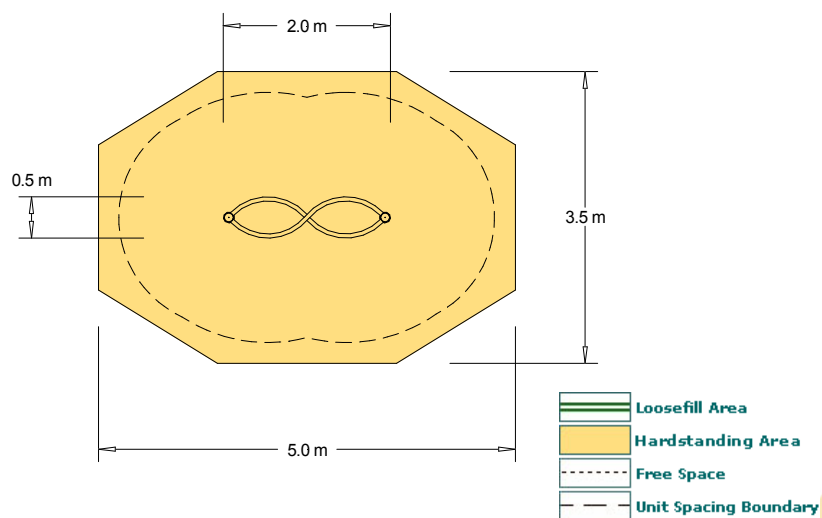
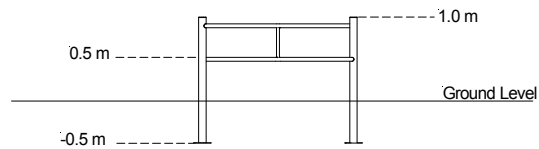

Technical Information	
Equipment Dimensions	
Length / Width / Height	2.0 x 0.5 x 1.0m
Surfacing and Area Required	
Minimum Space Required L/W/H	5.0 x 3.5 x 2.7m
Max Gradient Of Ground	1 in 30
Free Height Of Fall	-
Suggested Hardstanding Area	14.91m ²
Loosefill At 150mm	-
Bark / Cushionfall / Sand	-
Grasslok Tiles	-
Installation Information	
Overall Weight	45 kg
Heaviest Part	45 kg
Largest Part	2.0 x 1.5 x 0.5m
Longest Part	2.0m
Concrete Required	0.08m ³

Encounter 6

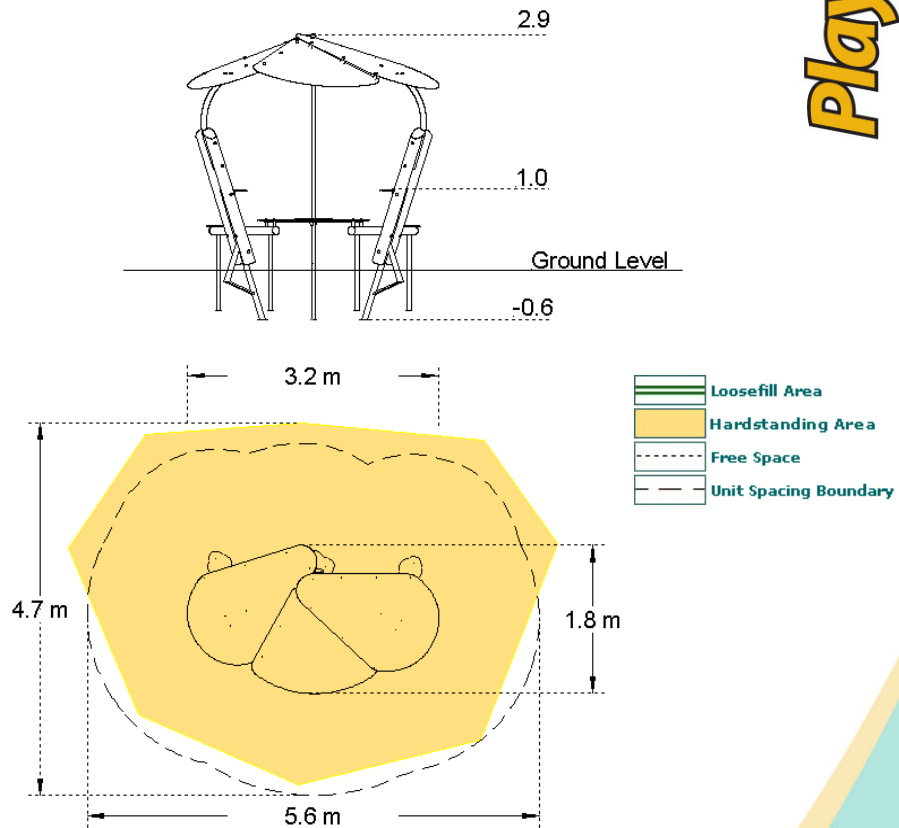

Technical Information	
Equipment Dimensions	
Length / Width / Height	1.8 x 3.2 x 2.9m
Surfacing and Area Required	
Minimum Space Required L/W/H	4.7 x 5.6 x 4.1m
Max Gradient Of Ground	1 in 30
Free Height Of Fall	-
Suggested Hardstanding Area	20.15 m ²
Loosefill At 150mm	-
Bark / Cushionfall / Sand	-
Grasslok Tiles	-
Installation Information	
Overall Weight	253 kg
Heaviest Part	28 kg
Largest Part	2.0 x 1.3 x 0.02m
Longest Part	3.5m
Concrete Required	0.57 m ³

PCM704
Meeting Point with Movable Hammocks

Meeting Point with Movable Hammocks

PCM704



Item no. PCM704-0902	
General Product Information	
Dimensions LxWxH	330x345x290 cm
Age group	4+
Play capacity (users)	12
Colour options	●

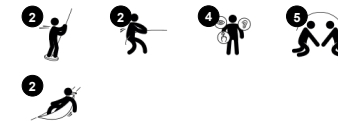

Data is subject to change without prior notice.

The invitation to socialise in a nice, varied framework allowing for interaction between different ages and abilities and allowing the space for bigger groups of users is always popular. Socialising in a framework allowing for different body positions and supporting those with both sturdy and swaying materials, that can be moved in cooperation, makes the

Double Meeting Point with Movable Hammocks an attraction for the school age children of all ages. The varied seating on the bar, on the seats and not least in the gently swaying hammocks that can be pushed closer to each other or further apart to suit varied play scenarios allows for users across ages, abilities and different group sizes to meet and interact.

FRE3000

Cosmos Meeting Point

Cosmos Meeting Point

FRE3000



This unique design is very spacious and appealing to all. The Meeting Point is the perfect place for getting together with friends or relaxing. The roof consists of 4 screens providing protection from all types of weather conditions, while also providing a great view of the sky. The curved design of the comfortable benches ensure eye contact with the other

users wherever they are sitting, as there are many different ways to sit on the comfortable benches.

1 / 04/22/2024

KOMPAN
Let's play

Item no. FRE3000-3417

General Product Information

Dimensions LxWxH	390x254x263 cm
Age group	3+
Play capacity (users)	-
Colour options	●



Data is subject to change without prior notice.

PCM701

Movable Hammocks

Movable Hammocks

PCM701



Socialising in a nice framework is a favourite occupation of school age children. These hammocks allow for flexible meetings, offering varied seating on the bar, on the seats and not least in the gently swaying hammocks. The hammocks can be pushed closer to each other or further apart to suit varied play scenarios and the whole unit allows for being used

seated, lying, or standing, thus allowing for users across ages, abilities and different group sizes to meet and interact.

1 / 04/22/2024



Item no. PCM701-0902	
General Product Information	
Dimensions LxWxH	331x243x65 cm
Age group	4+
Play capacity (users)	6
Colour options	●

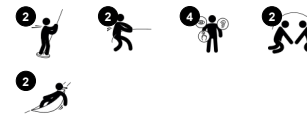

Data is subject to change without prior notice.

PCM702
Meeting Point

Meeting Point

PCM702



Socialising in a nice framework is a favourite occupation of school age children. This meeting point invites a break and can be combined with more modules to create a whole meeting area.

1 / 04/22/2024

KOMPAN
Let's play

Item no. PCM702-0902	
General Product Information	
Dimensions LxWxH	119x59x170 cm
Age group	4+
Play capacity (users)	2
Colour options	●



Data is subject to change without prior notice.

PCM703

Meeting Point with Bench

Meeting Point with Bench

PCM703



Socialising in a nice framework is a favourite occupation of school age children. This meeting point allows for groups of children having a break in the varied seating setting. The benches with and without roof and back support allow for different sorts of seated positions and cater for users across ages and abilities.

1 / 04/22/2024

KOMPAN
Let's play

Item no. PCM703-0902	
General Product Information	
Dimensions LxWxH	306x132x170 cm
Age group	4+
Play capacity (users)	6
Colour options	●



Data is subject to change without prior notice.

YOU240

Open Half Pod Shelter

SutcliffePlay

Product Specification

Half Pod Shelter

YOU040: Suitable for No Safety Surfacing Required

Play Type: Social, Inclusive

Suitability Information



Age Range:
All



Area:
46m²



Perimeter:
24.7m



HIC:
1.0m



Overall Weight:
514Kg



Heaviest Part:
110Kg



Longest Part:
3.23m



Product Description

Youth Shelter

A modular, all steel construction makes this Youth Shelter highly resilient and easy to clean. With an overhanging roof, sealed with specially designed waterproof rubber strips it keeps all users dry and provides great wind protection. Designed and developed through a series of consultations with a local authority and two secondary schools. It is available in two colour schemes, Red/Grey and Blue/grey.

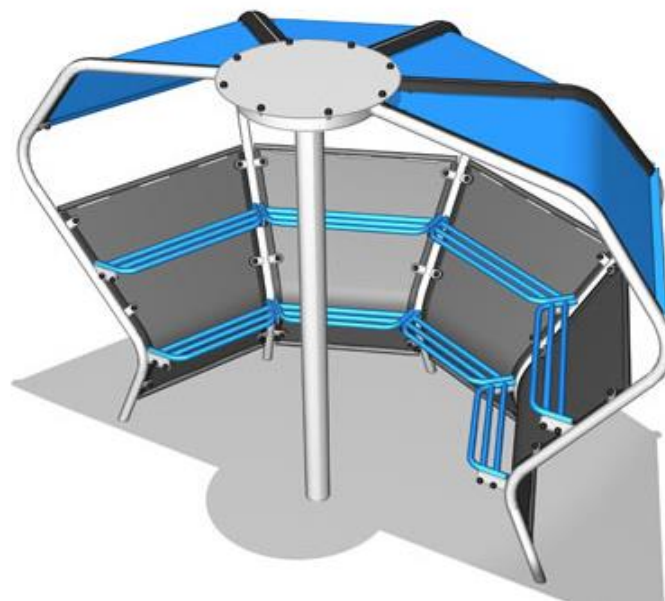
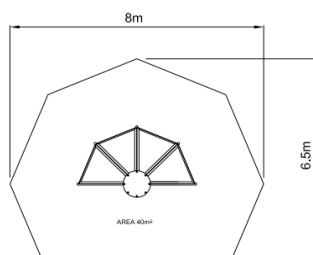

www.sutcliffeplay.co.uk

Product ref: YOU240

YOU245

Open Split Pod Shelter

SutcliffePlay

Product Specification

Value Split Pod Shelter

YOU245: No Safety Surfacing Required

Play Type: Social, Inclusive

Suitability Information



Age Range:
All



Area:
46.0m²



Perimeter:
24.7m



HIC:
1.0m



Overall Weight:
511Kg



Heaviest Part:
110Kg



Longest Part:
3.23m



Product Description

Youth Shelter

A modular, all steel construction makes this Youth Shelter highly resilient and easy to clean. With a 'bat wing' roof profile, it has no rubber elements but still provides seating and shelter. This version has been designed as a more open unit and is only available as a Half (YOU240) or Split Pod (YOU245).

All Pod Shelters have been designed and developed through a series of consultations with a local authority and two secondary schools. It is only available in two colour schemes, Purple or Blue.

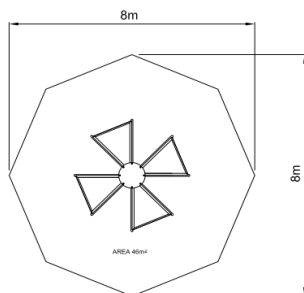

www.sutcliffeplay.co.uk

Product ref: YOU245

Arena Meeting Point (4 seat)

1 SECTION MEETING POINT (MPSEATS1)

**SUGGESTED MINIMUM TARMAC AREA - 5 Sq. Mtrs.
P.C.C. EDGING - 8 Mtrs.**

2 SECTION MEETING POINT (MPSEATS2)

**SUGGESTED MINIMUM TARMAC AREA - 5 Sq. Mtrs.
P.C.C. EDGING - 10 Mtrs.**

3 SECTION MEETING POINT (MPSEATS3)

**SUGGESTED MINIMUM TARMAC AREA - 6.5 Sq. Mtrs.
P.C.C. EDGING - 11.5 Mtrs.**

4 SECTION MEETING POINT (MPSEATS4)

**SUGGESTED MINIMUM TARMAC AREA - 7.5 Sq. Mtrs.
P.C.C. EDGING - 11 Mtrs.**

5 SECTION MEETING POINT (MPSEATS5)

**SUGGESTED MINIMUM TARMAC AREA - 8.5 Sq. Mtrs.
P.C.C. EDGING - 11.5 Mtrs.**

NOTES

REVISION	
REV.00 - ORIGINAL	ISSUE A
REV.01 - AMENDMENT BY A.J. CHE BY J.C. SEATING SPECIFICATIONS.	ISSUE B
REV.02 - AMENDMENT BY A.J. CHE BY A.J. DIMENSIONS AND NO VIEWS ADDED. SEATING SPECIFICATIONS.	ISSUE C
REV.03 - AMENDMENT BY A.J. CHE BY J.C. SEATING SPECIFICATIONS ADDED TO THIS SPEC.	ISSUE D
REV.04 - AMENDMENT BY A.J. CHE BY J.C. SUBJECTS = 5 ADDED. SEATING SPECIFICATIONS ADDED TO THIS SPEC. SEATING SPECIFICATIONS ADDED TO THIS SPEC.	ISSUE E

CUSTOMER

PROJECT

TITLE

**ARENA MEETING POINTS
STEEL SEAT OPTION**

SMP (Playgrounds) Ltd
The City Lane
Thorn, Epsom
Middlesex
United Kingdom

+44 (0) 1753 651000
+44 (0) 1753 421079
Email: sales@smpplaygrounds.co.uk

Playgrounds

SMP RECOMMENDS THE PROTECTION OF INFANTS' JOINTS AND BONES BY THE USE OF ALL PLAY EQUIPMENT

BS EN 1176

DATE	26/01/98	SCALE	1:50
DRAWN BY	J.B.	CHECKED BY	J.C.
DRAWING No.	20370	ISSUE	E

© SMP (Playgrounds) Ltd. 2008 SHEET 1 OF 3